

Pillow Talk

ASSEMBLY INSTRUCTION

MEI 2 TIER SIDE TABLE
RECTANGLE

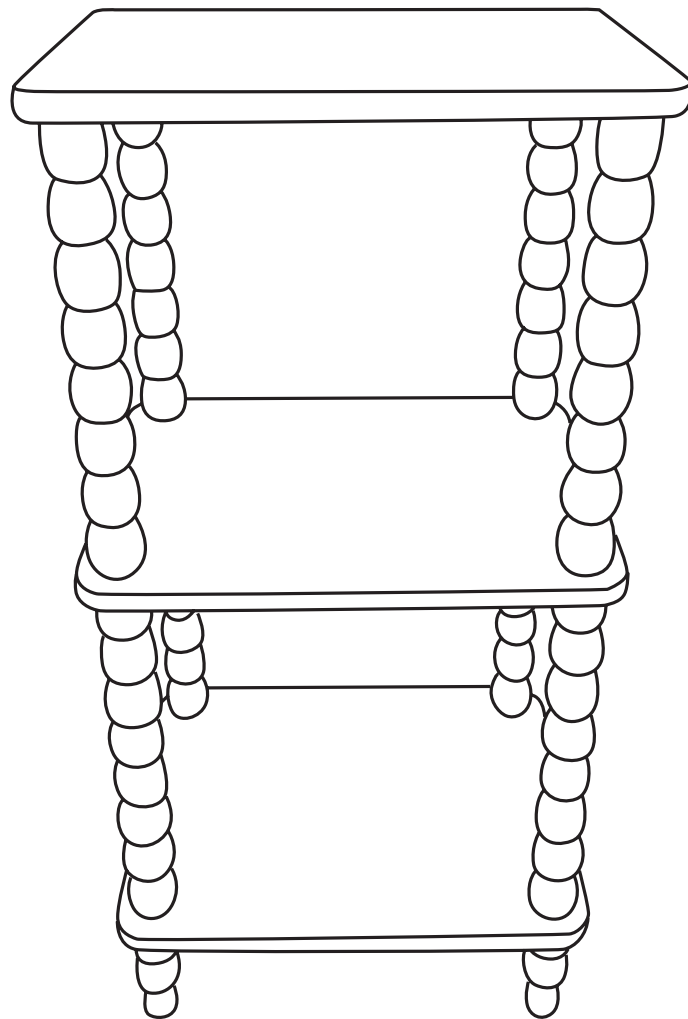



Children have died from furniture toppling over.

This product has been supplied with a wall strap to prevent toppling.

The fixing anchor for your wall is not provided since different surface materials require different attachments.

Please seek professional advice if you are in doubt of what fixing device to use.

ALWAYS secure this furniture with an anchor device.

IMPORTANT





- **Regularly check** that anchors are securely maintained.
- Do not overload.
- Place heavy objects in the lowest drawers.
- Never allow children to stand, climb or hang on drawers, doors or shelves.
- Stability of tall items may be affected by thick pile carpet or uneven floors.
- Do not put a TV or other heavy objects on top of furniture not intended for use with a TV.
- Never open more than one drawer at a time.

CAUTION

For your safety when attaching the anchor fixings, please note the following:

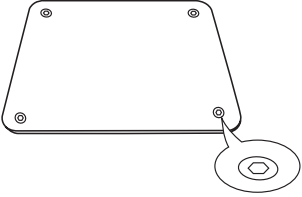
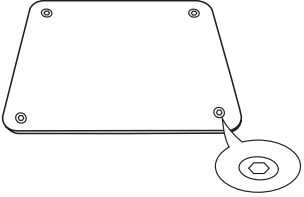
- Check for any electrical wires or plumbing inside the wall before drilling any holes (if you are unsure, please seek professional advice from a qualified tradesperson)
- Walls are constructed from different materials, for example, masonry (solid brick) or plasterboard lined cavity walls (hollow). It is important that you use the appropriate wall fittings for your wall type.
- Your local hardware store will have the necessary drills and fittings and can offer advice if needed. If in doubt, engage the services of a qualified tradesperson to install and anchor this product.

PARTS LIST

<p>(A)</p>  <p>Board contains no inside screw</p>	<p>(B)</p>  <p>Board contains an inside screw</p>	<p>(C)</p>  <p>C x 4</p>	<p>(D)</p>  <p>D x 4</p>	<p>(E)</p>  <p>E x 4</p>
--	--	---	---	---

ASSEMBLY STEPS

Read these instructions carefully. Refer to hardware and furniture parts list for guidance. Be sure all parts are complete, before assembling. place all hardware parts on a clean and flat soft surface to prevent scratches. Refer to steps provided as assembling guide.

CAUTIONS

- Do not FULLY-TIGHTEN the nuts or nut bolts until all are in place.
- To prevent thread damage. Ensure that nuts or nut bolts are not over-tightened.
- Hardware is to be kept out of reach of children.

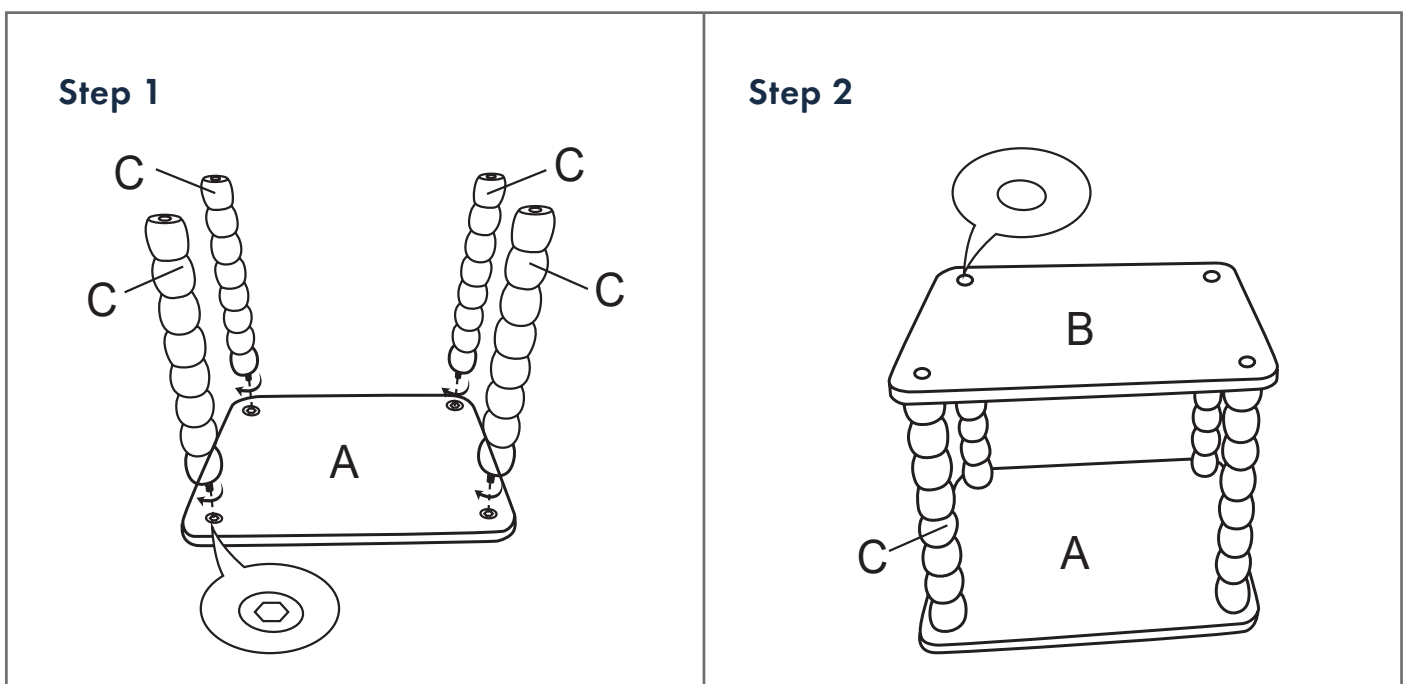

ASSEMBLY STEPS

Step 3

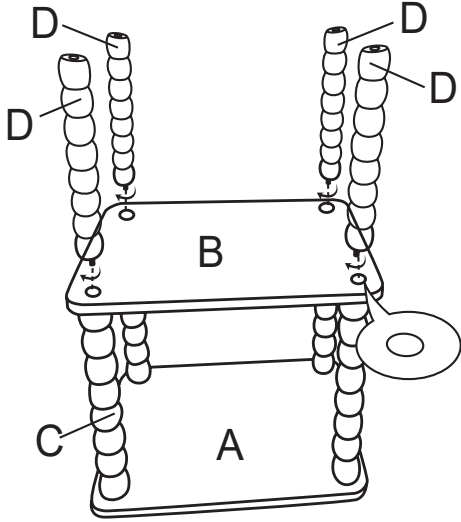

Step 4

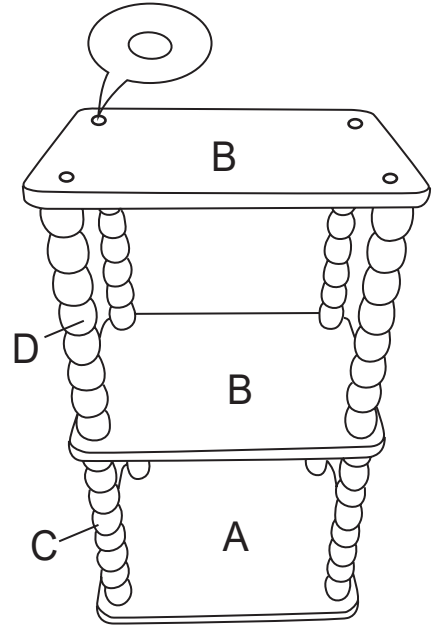

Step 5

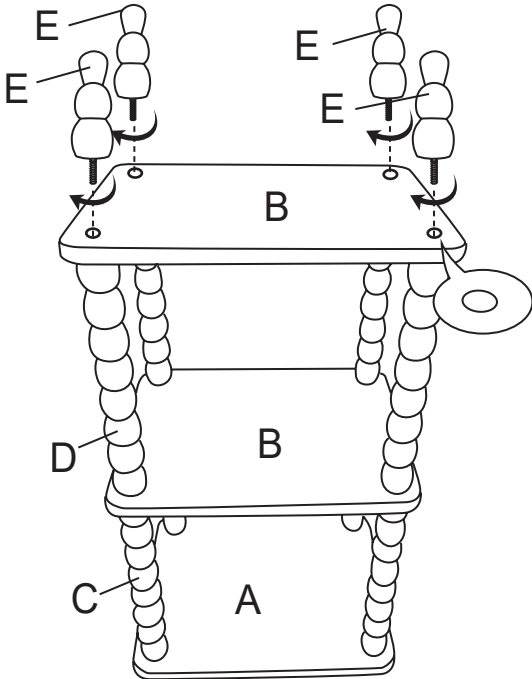

Step 6

